

## EMI reduction in PWM inverters using adaptive frequency modulation carriers

Liu, Dehong; Sugawara, Retsu; Orlik, Philip V.

TR2020-150 November 25, 2020

### Abstract

In this paper, we propose deterministic carrier frequency modulation (FM) techniques instead of random carrier frequency modulation (RCFM) to reduce EMI of carrier harmonics in PWM inverters. In particular, we first propose a linear frequency modulation (LFM) method to spread the carrier harmonic energy out in a certain frequency range. Second, considering the characteristic of EMI propagation from the EMI source to the victim under test, we propose a nonlinear frequency modulation (NFM) method to adaptively modulate the carrier frequency based on the EMI spectrum received by the victim such that the influence of propagation path can be properly compensated. Consequently the EMI spectrum received by the victim is flattened and the carrier harmonic EMI level is reduced. Simulation and experimental results validate our EMI reduction scheme using deterministic carrier frequency modulations.

*International Conference on Electrical Machines and Systems (ICEMS) 2020*



# EMI reduction in PWM inverters using adaptive frequency modulation carriers

Dehong Liu\*, Retsu Sugawara\*\*, and Philip Orlik\*

\* Mitsubishi Electric Research Laboratories, USA

\*\* Mitsubishi Electric, Japan

**Abstract**— In this paper, we propose deterministic carrier frequency modulation (FM) techniques instead of random carrier frequency modulation (RCFM) to reduce EMI of carrier harmonics in PWM inverters. In particular, we first propose a linear frequency modulation (LFM) method to spread the carrier harmonic energy out in a certain frequency range. Second, considering the characteristic of EMI propagation from the EMI source to the victim under test, we propose a nonlinear frequency modulation (NFM) method to adaptively modulate the carrier frequency based on the EMI spectrum received by the victim such that the influence of propagation path can be properly compensated. Consequently the EMI spectrum received by the victim is flattened and the carrier harmonic EMI level is reduced. Simulation and experimental results validate our EMI reduction scheme using deterministic carrier frequency modulations.

**Index Terms**— EMI, Carrier harmonics, PWM inverter, Frequency modulation.

## I. INTRODUCTION

Pulse Width Modulation (PWM) inverters are widely used in modern motor drive systems due to their high efficiency and wide range of adjustable output frequency. However, because of the large  $dv/dt$  and  $di/dt$  of their switching operations, PWM inverters may cause some side effects such as motor bearing current, over voltage at motor terminals, and electromagnetic interference (EMI)[1]. In particular, PWM inverters that use periodic triangular or sinusoidal carriers to generate PWM driving signals simultaneously generate harmonics of the carrier's fundamental frequency. These carrier harmonics typically contribute the major part of conducted EMI, causing the inverter to fail to meet required EMC standards or even lead to mis-operation [2].

In order to reduce the EMI level of PWM inverters to EMI victims, various schemes have been adopted or proposed from different perspectives in terms of EMI source, propagation path, and EMI victims. For example, filtering is the most common method to suppress conducted EMI by mitigating EMI with a bypass circuit. As another example, shielding aims at reducing radiated EMI by blocking the radiation path. Some other schemes, such as multi-level inverter and soft-switching techniques [3, 4], are specific methods for power electronic devices. All these schemes require extra hardware to implement in practice.

Besides the above classical EMI suppression or mitigation schemes, random carrier frequency modulation (RCFM) has attracted great attention as a way to suppress

EMI as well as acoustic noise in PWM inverters[5-10]. It is well known that the EMI spectrum of PWM inverters includes strong spikes located at carrier harmonics. The basic idea of RCFM is to randomize the carrier frequency in a certain frequency range such that the carrier harmonic energy can be spread out in the corresponding frequency range. Consequently, each spike of carrier harmonic in the EMI spectrum is replaced by a relatively flat spectrum in a certain frequency band, resulting in a reduced EMI level. However, due to its random nature, RCFM works well in a statistical sense and is relatively difficult to implement with hardware.

Following the idea of spreading EMI energy as is done in RCFM, in this paper we propose two deterministic frequency modulation methods to reduce EMI. First, we propose a linear frequency modulation (LFM) method to uniformly spread the EMI source spectrum such that the EMI *source* generates a flat spectrum in a certain range. Second, considering that the EMI propagation path is very complicated and furthermore the EMI level at a victim under test is not necessarily flat as desired, we propose a nonlinear frequency modulation (NFM) method in which we adaptively modulate frequency based on the EMI spectrum of LFM to compensate the propagation distortion and to achieve a desired flat EMI spectrum at the *victim*. The main advantage of our proposed frequency modulation scheme is that our method is deterministic, and it is straight forward to implement with hardware.

Our simulation and experimental results demonstrate the effectiveness of our proposed methods.

## II. PWM CARRIER AND EMI

In power electronic inverters, the PWM switching signal is generated by a PWM comparator with two input signals. One is called reference signal (also called modulation signal), which is typically a sinusoidal signal of a desired reference frequency. The other is carrier signal, which can be a sinusoidal or a triangular signal, of a much higher carrier frequency than the reference frequency. By comparing the reference signal and the carrier signal, the output PWM waveform is a train of rectangular pulses with different widths to control the operation of switching devices.

### A. Periodic carrier

Let  $f_c$  be the carrier frequency and  $f_r$  be the reference frequency. The sine carrier signal can be represented by

$$c_s(t) = A \sin[\phi_c(t)] = A \sin(2\pi f_c t + \phi_0), \quad (1)$$

where  $A$  is the amplitude,  $\phi_c(t) = 2\pi f_c t + \phi_0$  is the

phase of the sine carrier signal, and  $\phi_0$  is the initial phase. Correspondingly, the triangular carrier signal that shares the same peak values and the same peak locations of (1) can be represented by [11]

$$c_T(t) = A[2\frac{\phi_c(t)}{\pi} - 2[\frac{\phi_c(t)}{\pi} + \frac{1}{2}]](-1)^{\lfloor \frac{\phi_c(t)}{\pi} + \frac{1}{2} \rfloor}, \quad (2)$$

where  $\lfloor \cdot \rfloor$  is the floor function that gives the greatest integer less than the input real number as output.

Further Fourier analysis of the PWM inverter output shows that it includes abundant harmonic frequency components of order  $(nf_c \pm kf_r)$ , where  $n$  and  $k$  are non-negative integers[7]. When  $n = 0$  and  $k = 1$ , the harmonic corresponds to the fundamental frequency  $f_r$  of PWM output. After a low-pass filtering process, most of the harmonic frequency components are suppressed and a decent sinusoidal signal of the reference frequency  $f_r$  can be achieved. However, it is inevitable to have conducted or radiated EMI of carrier harmonics to some extent.

### B. Linear frequency modulation (LFM) carrier

Random carrier frequency modulation (RCFM) has been proved to be an effective way to spread out the harmonic energy in the frequency domain and consequently to lower down the EMI level. However, RCFM only provides improved performance statistically, not in a deterministic way. Since the carrier frequency is randomly modulated, the PWM inverter may perform differently when a different random modulation is employed. To avoid this problem, in this paper we consider deterministic frequency modulation methods instead of RCFM to reduce EMI.

We first consider a linear frequency modulation (LFM) carrier. LFM signals have been widely used in communication and radar areas. For example, an LFM chirp signal typically used in radar systems has a flat spectrum in its spanned frequency range. Therefore, if we use an LFM carrier, we can spread the harmonic spike energy in the EMI spectrum over a certain frequency range.

Let the time-domain LFM carrier signal be

$$c_{LS}(t) = A\sin[\phi_{LM}(t)] = A\sin\{2\pi[u(t)f_a + f_b]t + \phi_0\}, \quad (3)$$

where  $\phi_{LM}(t)$  is the phase of the LFM sine carrier,  $f_a$  and  $f_b$  are two frequency parameters, and  $u(t)$  is a sawtooth signal of period  $T$ , which can be written as

$$u(t) = 2\left[\frac{t}{T} - \left\lfloor \frac{t}{T} \right\rfloor\right] - 1. \quad (4)$$

The linear modulated frequency  $f_{LM}(t)$  can be formulated as

$$f_{LM}(t) = \frac{1}{2\pi} \frac{\partial \phi_{LM}(t)}{\partial t} = 2u(t)f_a + f_a + f_b. \quad (5)$$

We observed that  $f_{LM}(t)$  has a sweep period of  $T$ , i.e.  $f_{LM}(t + mT) = f_{LM}(t)$  for any integer number  $m$ . Assuming that for each sweep period, the carrier frequency is monotonically increased from  $f_{min}$  to  $f_{max}$ , we have the carrier's frequency range

$$[f(0), f(T)] = [f_b - f_a, f_b + 3f_a] = [f_{min}, f_{max}]. \quad (6)$$

It is clear that given a fixed total of EMI energy, the wider the sweep frequency range, the lower the EMI level. However, in practice the frequency range is restricted by various constraints. The lowest carrier frequency  $f_{min}$  is typically constrained by the total harmonic distortion

(THD) of the output voltage. If the carrier frequency is too low, the THD of output may be unacceptably high. The highest carrier frequency  $f_{max}$  is generally limited by the switching speed of devices or switching loss. Once  $f_{min}$  and  $f_{max}$  are determined, parameters  $f_a$  and  $f_b$  can be calculated according to (6). In summary, the linear modulated frequency  $f_{LM}(t)$ , the carrier's phase  $\phi_{LM}(t)$ , and the carrier signal  $c_{LS}(t)$  can be expressed respectively as

$$f_{LM}(t) = u(t) \frac{f_{max} - f_{min}}{2} + \frac{f_{max} + f_{min}}{2}, \quad (7)$$

$$\phi_{LM}(t) = 2\pi \left[ u(t) \frac{f_{max} - f_{min}}{4} + \frac{f_{max} + 3f_{min}}{4} \right] t + \phi_0. \quad (8)$$

and

$$c_{LS}(t) = A\sin\{2\pi \left[ u(t) \frac{f_{max} - f_{min}}{4} + \frac{f_{max} + 3f_{min}}{4} \right] t + \phi_0\}. \quad (9)$$

The bandwidth of the carrier signal is

$$BW = f_{max} - f_{min}. \quad (10)$$

The central frequency  $f_{ct}$  is

$$f_{ct} = \frac{f(T) + f(0)}{2} = \frac{f_{max} + f_{min}}{2}. \quad (11)$$

The equivalent frequency that yields the same number of switching operations can be presented as

$$f_{eq} = \frac{\phi_{LM}(T) - \phi_{LM}(0)}{2\pi T} = \frac{f_{max} + f_{min}}{2}. \quad (12)$$

To achieve the corresponding LFM triangle carrier, we simply replace  $\phi_c$  in equation (2) with  $\phi_{LM}$  in equation (8) as follows,

$$c_{LT}(t) = A[2\frac{\phi_{LM}(t)}{\pi} - 2[\frac{\phi_{LM}(t)}{\pi} + \frac{1}{2}]](-1)^{\lfloor \frac{\phi_{LM}(t)}{\pi} + \frac{1}{2} \rfloor}. \quad (13)$$

### C. Nonlinear frequency modulation (NFM) carrier

In the previous sub-section, we designed an LFM carrier to spread the harmonic spike energy out over a desired frequency range. This spread harmonic EMI energy is uniformly distributed at the inverter output as the EMI source. Considering the characteristics of EMI propagation, the EMI spectrum received at the victim under test is generally not flat anymore. To further investigate the influence of propagation paths, we simplify the EMI propagation as an equivalent circuit including an EMI source  $E(j\omega)$ , an equivalent series impedance  $Z_1(j\omega)$  of propagation paths, and a series impedance  $Z_2(j\omega)$  of victim, where  $\omega = 2\pi f$  is the angular frequency.

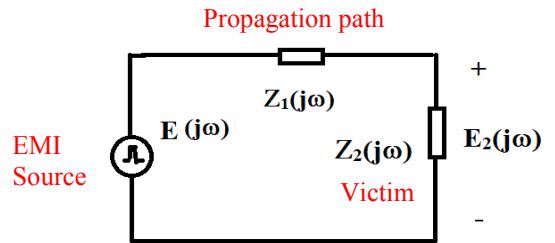

Fig. 1 Schematic illustration of EMI propagation

The EMI received by the victim is

$$E_2(j\omega) = \frac{Z_2(j\omega)}{Z_1(j\omega) + Z_2(j\omega)} \times E(j\omega). \quad (14)$$

Since the EMI propagation path is very complicated, as represented by the frequency dependent impedance

$Z_1(j\omega)$ , the factor between the EMI source  $E(j\omega)$  and the EMI received by the victim  $E_2(j\omega)$  is not a constant across the whole frequency range but rather frequency dependent. In order to achieve a desired EMI magnitude spectrum  $E_2(j\omega)$  at the victim side, we propose a nonlinear frequency modulation (NFM) scheme to adaptively modulate the carrier's frequency. By this means, the EMI spectrum at the source  $E(j\omega)$  is pre-distorted and non-flat. However, when this spectrum distortion acted on by the propagation channel, a flat EMI spectrum  $E_2(j\omega)$  is received by the victim.

Let the EMI power spectrum received by the victim be  $M(f)$  when an LFM carrier is utilized, where  $f \in [f_{min}, f_{max}]$ , and a desired victim EMI power spectrum be  $D(f)$ . Note that here we use a power spectrum instead of magnitude spectrum to simplify the following inferences. Since carrier frequency modulation will not change the total number of switching operations, but only dither the time of each switching operation, the total EMI emission energy remains the same. Therefore, for discrete uniform frequency sampling  $[f_{min} = f_1 < f_2 < f_3 < \dots < f_N = f_{max}]$ , we have

$$\sum_{i=1}^N M(f_i) = \sum_{i=1}^N D(f_i). \quad (15)$$

It is straightforward to prove that the peak EMI level within the sweep frequency range satisfies

$$\max_{f_i}(M(f_i)) > \text{mean}_{f_i}(M(f_i)) = D(f_i) = \max_{f_i}(D(f_i)). \quad (16)$$

Therefore, a minimal EMI level is achieved when the desired EMI spectrum is flat.

Let the nonlinear modulated frequency be  $f_{NM}(t_i) = f_i$ , which is of the same sweep period  $T$  and of the same sweep frequency range. For each sweep period we monotonically increase the carrier frequency from  $f_{min}$  to  $f_{max}$ . For simplicity, we consider the first sweep period in which at time  $t_i$  ( $0 = t_1 \leq t_i \leq t_N = T$ ) the frequency  $f_i$  is swept. It is clear that the sweep duration of frequency  $f_i$  will proportionally impact the EMI spectrum energy at frequency  $f_i$ . Based on this knowledge, we define a weight function  $w(f_i)$  proportional to the sweep duration of frequency  $f_i$  as follows,

$$w(f_i) = \alpha \cdot \left[ t_{i+\frac{1}{2}} - t_{i-\frac{1}{2}} \right] = \alpha \left[ t \left( \frac{f_{i+1}+f_i}{2} \right) - t \left( \frac{f_i+f_{i-1}}{2} \right) \right], \quad (17)$$

such that

$$M(f_i)w(f_i) = D(f_i), \quad (18)$$

where  $\alpha$  is an unknown constant to be determined, and  $t_{i+\frac{1}{2}}$  is the time when frequency  $\frac{f_{i+1}+f_i}{2}$  is swept. With boundary conditions  $t_{\frac{1}{2}} = t_1 = 0$  and  $t_{N+\frac{1}{2}} = t_N = T$ , we derive from (17) that

$$\sum_{i=1}^{i=N} w(f_i) = \alpha T. \quad (19)$$

According to (17), (18), and (19), we have

$$t_{i+\frac{1}{2}} = t_{i-\frac{1}{2}} + T \frac{1/M(f_i)}{\sum_{i=1}^{i=N} 1/M(f_i)}, \quad i = 1, \dots, N-1. \quad (20)$$

Then the frequency is modulated adaptively according to

$$f_{NM} \left( t_{i+\frac{1}{2}} \right) = \frac{f_i + f_{i+1}}{2}, \quad (21)$$

where the time  $t_{i+\frac{1}{2}}$  is determined by (20). For time

$t \in [t_{i-\frac{1}{2}}, t_{i+\frac{1}{2}}]$ , the frequency is modulated linearly, i.e.,

$$f_{NM} \left( t_{i-\frac{1}{2}} \leq t \leq t_{i+\frac{1}{2}} \right) = \frac{f_{i-1}+f_i}{2} + \frac{t-t_{i-\frac{1}{2}}}{t_{i+\frac{1}{2}}-t_{i-\frac{1}{2}}} \cdot \frac{f_{i+1}-f_{i-1}}{2}. \quad (22)$$

From (20) we can see that the sweep duration of frequency  $f_i$ , which is  $(t_{i+\frac{1}{2}} - t_{i-\frac{1}{2}})$ , is inversely proportional to the corresponding EMI energy  $M(f_i)$ . Therefore, the frequency that has small spectrum energy when using the LFM carrier will have a long sweep time inversely proportional to the energy for the NFM carrier to accumulate more spectrum energy, and vice versa. Since the product of spectrum energy at each particular frequency and its corresponding sweep time keeps a constant, meaning that the accumulated energy of different frequency will be equal, the final EMI spectrum of the NFM carrier will be flat in the sweep frequency range. As we proved in (16), this uniformly distributed EMI spectrum is the minimal EMI level we can achieve within the sweep frequency range by using an NFM carrier.

Note that this nonlinear frequency modulation is based on the EMI spectrum received by the victim when an LFM carrier is used, in which the influence of EMI propagation from the source to the victim is embedded. Therefore, this NFM scheme can be applied to different devices to reduce the EMI level by adaptively modulating carrier frequency.

Once we have  $f_{NM}(t_i) = f_i$ , we get the carrier's phase

$$\phi_{NM}(t_j) = 2\pi \int_0^{t_j} f_{NM}(t) dt, \quad (23)$$

where  $0 \leq t_j \leq T$ . For any time  $t$ , we summarize general expressions of the carrier's phase as

$$\phi_{NM}(t) = \phi_{NM} \left( T \left( \frac{t}{T} - \left\lfloor \frac{t}{T} \right\rfloor \right) \right) = \phi_{NM} \left( \frac{u(t)+1}{2} T \right), \quad (24)$$

the NFM sine carrier as

$$c_{NS}(t) = A \sin[\phi_{NM}(t)], \quad (25)$$

and the NFM triangle carrier as

$$c_{NT}(t) = A \left[ 2 \frac{\phi_{NM}(t)}{\pi} - 2 \left\lfloor \frac{\phi_{NM}(t)}{\pi} + \frac{1}{2} \right\rfloor \right] (-1)^{\left\lfloor \frac{\phi_{NM}(t)}{\pi} + \frac{1}{2} \right\rfloor}. \quad (26)$$

From (21)-(26) we can see that the implementation of our NFM scheme is straightforward. Given the input of measured EMI spectrum  $M(f)$ , the NFM carrier can be realized by simple hardware/software such as a sawtooth signal  $u(t)$  generator in (24) and an integrator in (23).

### III. SIMULATIONS

To evaluate our method, we perform simulations on a three-phase PWM inverter, with its schematic diagram shown in Fig. 2. We use matlab simulink to simulate the waveforms and EMI spectrum measured using a line impedance stabilization network (LISN). A resolution bandwidth RBW=200Hz and a sampling rate  $f_s = 60\text{MHz}$  are used for the spectrum analyzer to measure conducted EMI. For comparison, we consider a 20kHz triangle carrier and a LFM sine carrier of the same equivalent frequency  $f_{eq} = 20\text{kHz}$ , in the range of [10kHz, 30kHz], with a sweep period  $T=5\text{ms}$ . Therefore, we can get the LFM sine carrier signal as shown in equation (9) with parameters  $f_{min} = 10\text{kHz}$  and  $f_{max} = 30\text{kHz}$ .

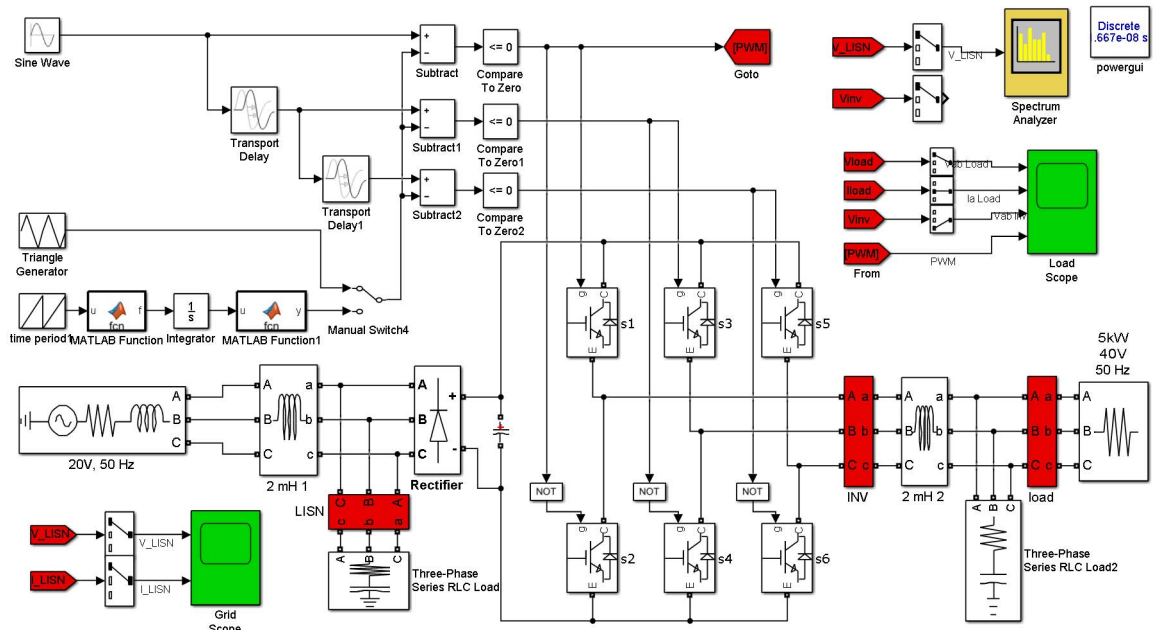
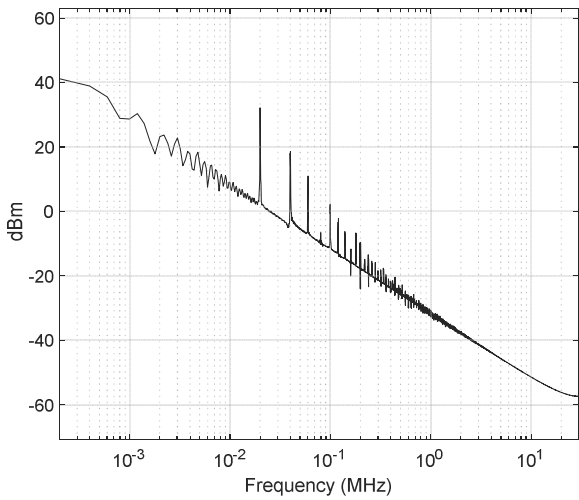
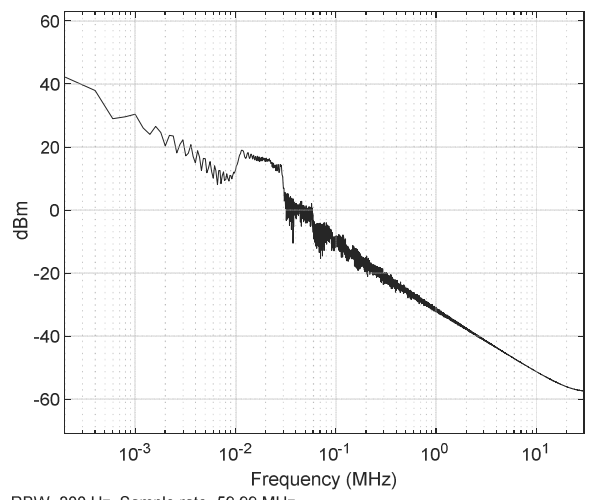

Fig. 2. Diagram of PWM inverter used in simulation



RBW=200 Hz, Sample rate=59.99 MHz  
(a) EMI power spectrum using a 20kHz triangular carrier



RBW=200 Hz, Sample rate=59.99 MHz  
(b) EMI power spectrum using a LFM sine carrier

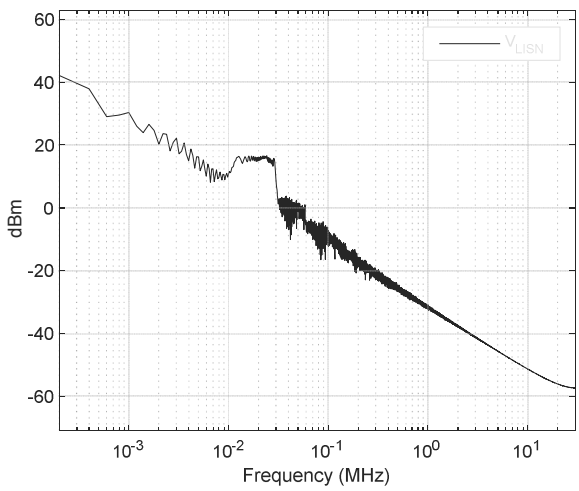

RBW=200 Hz, Sample rate=59.99 MHz  
(c) EMI power spectrum using an adaptive NFM sine carrier

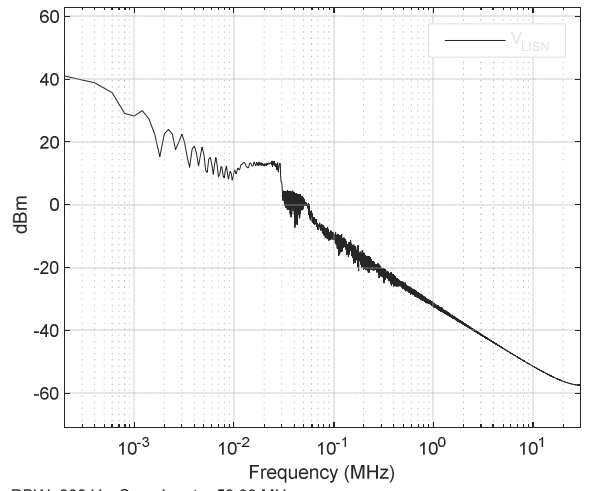

RBW=200 Hz, Sample rate=59.99 MHz  
(d) EMI power spectrum using an adaptive NFM triangular carrier

Fig. 3. Comparison of EMI power spectra using different carriers.

We show in Fig. 3(a) the simulated EMI spectrum of the LISN when a periodic triangle carrier is used. From the spectrum, we clearly observe harmonic peaks at frequency  $f_c$ , where  $n = 1, 2, 3, \dots$ . If we zoom in these harmonic peaks, we also observe some small side lobes which can be represented as  $(nf_c \pm kf_r)$ . When we use an LFM sine carrier of frequency ranging from 10kHz to 30kHz, the harmonic spectra are spread out in the corresponding frequency ranges, as shown in Fig. 3(b). We notice that the corresponding harmonic EMI level is reduced from 32.1dBm to 19.1dBm, with a reduction of 13dB. However, we notice that although the EMI level is reduced, the spread EMI spectrum is not flat due to the frequency-dependent propagation characteristics. This non-uniformly distributed EMI energy provides us an opportunity to reduce the EMI level further.

In order to flatten the EMI spectrum, we adopt our proposed adaptive NFM scheme to generate an NFM sine carrier, with the same sweep frequency range. The result using the adaptive NFM sine carrier is shown in Fig. 3(c), where we notice that the EMI spectrum in the range of [10kHz, 30kHz] is flattened to 16.7dBm with 2.4dB more reduction compared to that shown in Fig. 3(b). At the same time, there is no noticeable change in the lower frequency range, which means the fundamental frequency is not influenced.

Furthermore, if we change the adaptive NFM sine carrier to adaptive NFM triangle carrier, the EMI level is reduced to 13.9dBm, as shown in Fig. 3(d). Another 2.8dB EMI reduction is achieved, leading to a total of 18.2dB EMI reduction compared to that shown in Fig. 3(a) without any frequency modulation.

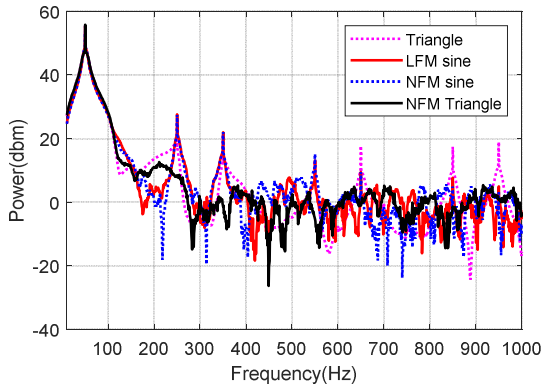

Fig. 4. Comparison of harmonics of the fundamental frequency component.

To further evaluate the influence of our EMI reduction scheme to the fundamental frequency component and its harmonics, we simulate the frequency spectrum of the inverter output line-to-line voltage in a low range frequency of [0, 10kHz] using matlab simulink with RBW=1Hz. We plot its power spectra using different carriers in Fig. 4 respectively, in the range of [0, 1kHz] for a better visual quality. We observe that the 5<sup>th</sup>, 7<sup>th</sup>, 11<sup>th</sup>, and 13<sup>th</sup> order harmonics are significantly suppressed by using our proposed adaptive NFM triangle carrier. To

quantitatively analyze the performance, we compute the total harmonic distortion (THD) of the inverter output line-to-line voltages using

$$THD = \frac{\sqrt{\sum_{j=2}^{200} V_j^2}}{V_1} \times 100\% , \quad (27)$$

where  $V_j$  is the RMS voltage of the  $j^{th}$  harmonic and  $j = 1$  corresponds to the fundamental frequency of 50Hz. The THDs of inverter output voltages using the triangle carrier, the LFM sine carrier, the NFM sine carrier, and the NFM triangle carrier are 7.9%, 6.6%, 6.7%, and 4.8%, respectively. It is clear that the NFM triangle carrier also yields the best performance in terms of THD.

#### IV. EXPERIMENT

We carry out an experiment on a three-phase 3kW PWM inverter. A picture of the experimental setup is shown in Fig. 5. The PWM power conversion circuit provides power for an LCR load. A Rohde&Schwarz (ESR7) EMI receiver is used to measure the conducted EMI from 10kHz to 30MHz via a LISN connected between the power supply and the conversion circuit.

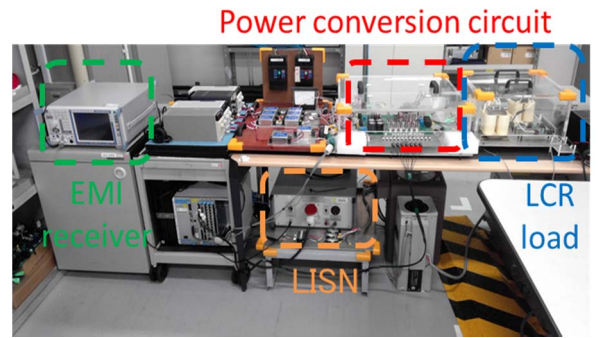

Fig. 5. Experiment setup

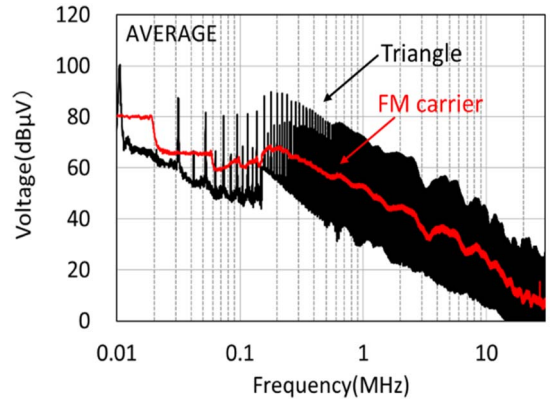

Fig. 6. Comparison of EMI power spectra using triangle and FM carriers

For comparison, two different carriers are considered in our experiments, i.e., a periodic triangle carrier of 10.5kHz and an FM carrier of sweep frequency range of [1kHz, 20kHz]. EMI spectra are measured in [10kHz, 30MHz] for both carriers under the same input power and load condition. The measured EMI spectra are shown in Fig. 6 for comparison, where the spectrum in black is measured when a triangle carrier is used, and the spectrum in red is

measured when an LFM carrier is used for the PWM driving signal, respectively. We observe that the EMI spectrum of the LFM carrier is lower than that of the periodic triangle carrier by about 20dB across the whole frequency range of conducted EMI. This EMI reduction demonstrates that we can reduce EMI by using a deterministic LFM carrier for the PWM conversion circuit.

## V. CONCLUSION

We propose two deterministic carrier frequency modulation (FM) methods, a linear frequency modulation (LFM) method and a nonlinear adaptive frequency modulation (NFM) one, instead of random carrier frequency modulation (RCFM) to reduce conducted EMI in PWM inverters. We demonstrate by simulations that with a LFM carrier, we can reduce the harmonic EMI level by spreading the EMI energy out in a certain frequency range. More importantly, the EMI level as well as harmonics of fundamental frequency components can be further reduced with our proposed NFM scheme by adaptively modulating the frequency of a triangle carrier, based on the EMI spectrum using the LFM carrier. We validate our proposed scheme with matlab simulink simulations. Our experiment on a three-phase inverter also validates our proposed methods on EMI reduction.

## REFERENCES

- [1] Y. Hou, D. Liu, J. Jiang, L. Huang, S. Makot, and T. Shinzo. "An effective method to determine voltage waveform at terminal of induction motor fed by PWM inverter." *In Proc. of Third International Power Electronics and Motion Control Conference(IPEMC'2000)*, vol. 3, pp. 1425-1430, 2000.
- [2] D. Liu, J. Jiang, and Z. Zhao, "A systematic approach to analyze EMI in control circuit of power electronic equipment," *In Proc. of Sixteenth Annual IEEE Applied Power Electronics Conference and Exposition (APEC)* , Anaheim, CA, USA , vol. 1, pp. 208-212.
- [3] H. Zhang, A. V. Jouanne, S. Dai, A. K. Wallace, "Multilevel Inverter Modulation Schemes to Eliminate Common-Mode Voltages," *IEEE Trans. Industry Applications*, vol.37, no.1, pp. 3-3, 2001.
- [4] A. Videt, P. Baudesson, J. J. Franchand, J. Ecrabey, "Motor Overvoltage Limitation by Means of a New EMI Reducing PWM strategy for Three-level Inverters," *IEEE Trans. Industry Applications*, vol.45, no.5, pp. 1678-1687, 2009.
- [5] T. G. Habetler, and D. M. Deepakraj. "Acoustic noise reduction in sinusoidal PWM drives using a randomly modulated carrier." *IEEE Trans. Power Electronics* vol.6 no.3 (1991): 356-363.
- [6] A. M. StankoviÄ, "Random pulse modulation with applications to power electronic converters (Doctoral dissertation)", *Massachusetts Institute of Technology*, 1993.
- [7] K. K. Tse, H. S. H. Chung, S. R. Hui, and H. C. So, "A comparative study of carrier-frequency modulation techniques for conducted EMI suppression in PWM converters," *IEEE Trans. Industrial Electronics*, vol. 49, no. 3, pp.618-627.
- [8] H. Li, Z. Li, B. Zhang, F. Wang, N. Tan, and W. A. Halang, "Design of analogue chaotic PWM for EMI suppression," *IEEE Trans. Electromagnetic Compatibility*, vol. 52, no. 4, pp.1001-1007.
- [9] A. Dove, J. Naudé, and I. Hofsjager. "An argument for the relationship between spectral spreading and probability spreading for EMI-reduction in DC-DC converter." *IEEE Trans. Power Electronics* 35.2 (2019): 1459-1472.
- [10] A. A. Fardoun, E. H. Ismail, "Reduction of EMI in AC Drives Through Dithering Within Limited Switching Frequency Range," *IEEE Trans. Power Electronics*, vol. 24, no. 3, pp. 804-811, 2009.
- [11] E. W. Weisstein, "Fourier series—triangle wave", *Wolfram Web Resource*, 2017.